



DESCRIPTION:

- Classic Style
- Left or Right Drain.
- High gloss / Crack-resistant acrylic.
- Made in Canada.
- Complies with CSA & IAPMO standards.

AVAILABLE OPTIONS:

- Biscuit & black Colour.
- 3/4 Set back wood apron.
- Removable access panel.
- Skirt cut-off.
- Plain skirt.
- Double tilling flange.
- Textured Bottom

JETTING OPTIONS:

- Lateral Air jets.
- Air illusion jets.
- Filler air jets.
- Square zen jets.
- Neck-Jet massage system.
- Whirlpool jets.
- V-Masseuse.
- Chromatherapy.
- Aromatherapy.
- Comfort Warm

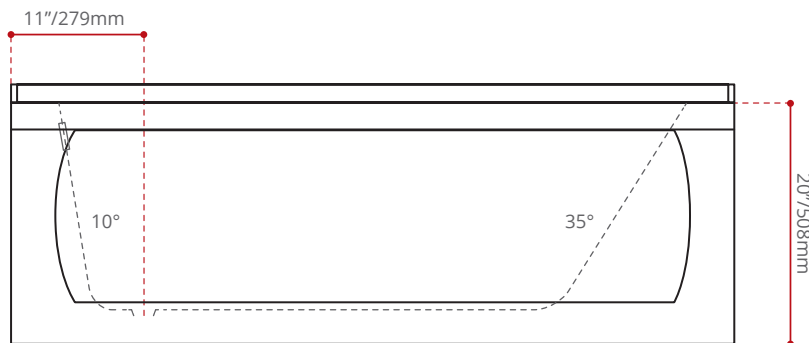
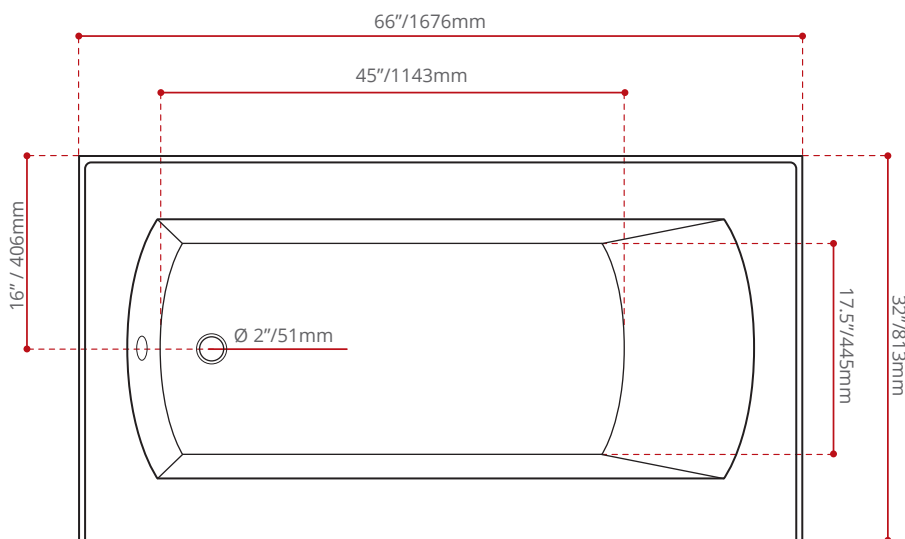

WATER DEPTH

13.5"/343mm

CAPACITY

58.69 gal.
222 litres of water

SHIPPING DIMENSIONS

68 x 34 x 24" / 1727 x 864 x 610mm

NET WEIGHT

33.1 kg / 73 lbs

GROSS WEIGHT

40 kg / 88 lbs

Measurements may vary ±5mm
- Diagram NOT to scale -

